

**GIA COLORED DIAMOND REPORT**

June 16, 2014  
 Report Type ..... Grading Report  
 GIA Report Number ..... 2176425818  
 Shape and Cutting Style ..... Pear Modified Brilliant  
 Measurements ..... 6.15 x 4.29 x 2.81 mm  
  
 Carat Weight ..... 0.55 carat  
 Color Grade ..... Fancy Intense Yellow  
 Color Origin ..... Natural  
 Color Distribution ..... Even  
 Clarity Grade ..... VS1  
 Proportions:

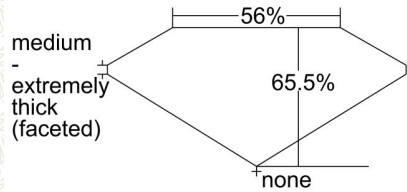

Profile not to actual proportions



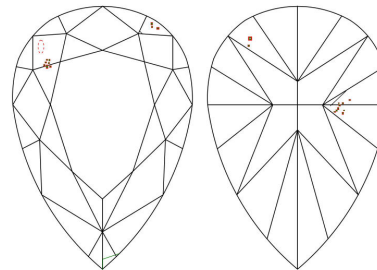

Polish ..... Good  
 Symmetry ..... Good  
 Fluorescence ..... Faint

**ADDITIONAL INFORMATION**

**CLARITY CHARACTERISTICS**



**KEY TO SYMBOLS\***

-  Cloud
-  Etch Channel
-  Natural
-  Extra Facet

\* Red symbols denote internal characteristics (inclusions). Green or black symbols denote external characteristics (blemishes). Diagram is an approximate representation of the diamond, and symbols shown indicate type, position, and approximate size of clarity characteristics. All clarity characteristics may not be shown. Details of finish are not shown.

**GIA COLORED DIAMOND SCALE**

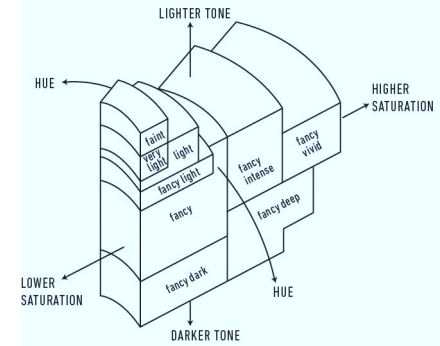

Illustration of GIA fancy color grade interrelationships

**GIA CLARITY SCALE**

VERY VERY SLIGHTLY INCLUDED	FLAWLESS
	INTERNALLY FLAWLESS
VERY VERY SLIGHTLY INCLUDED	VVS <sub>1</sub>
	VVS <sub>2</sub>
VERY SLIGHTLY INCLUDED	VS <sub>1</sub>
	VS <sub>2</sub>
SLIGHTLY INCLUDED	SI <sub>1</sub>
	SI <sub>2</sub>
INCLUDED	I <sub>1</sub>
	I <sub>2</sub>
	I <sub>3</sub>



The results documented in this report refer only to the diamond described, and were obtained using the techniques and equipment used by GIA at the time of examination. This report is not a guarantee or valuation. For additional information and important limitations and disclaimers, please see [www.gia.edu/terms](http://www.gia.edu/terms) or call +1 800 421 7250 or +1 760 603 4500. ©2014 Gemological Institute of America, Inc.

[reportcheck.gia.edu](http://reportcheck.gia.edu)



 THE SECURITY FEATURES IN THIS DOCUMENT, INCLUDING THE HOLOGRAM, SECURITY SCREEN AND MICROPRINT LINES, IN ADDITION TO THOSE NOT LISTED, EXCEED DOCUMENT SECURITY INDUSTRY GUIDELINES.